



Xorel Artform[®]
Product Specification Sheet



Xorel Artform[®]

Xorel Artform is a versatile acoustical panel system that combines the beauty and performance of Xorel textiles with proven sound absorbing capabilities to transform interior wall spaces in form and function without disruption

Shapes and Sizes

Standard Panels

Diamond

Small



Medium



Large



Square

Small



Large

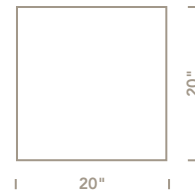

Hex

Small



Medium



Large

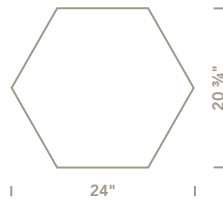

Tall Hex

Small



Medium



Large

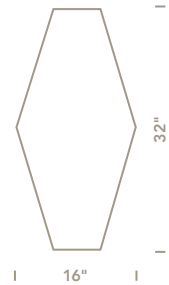

Plank

Small



Large



Waveline

Small



Medium

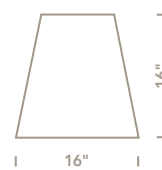

Large

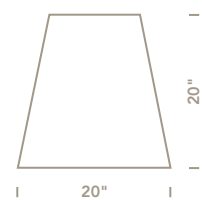

Scale

Small



Medium



Large

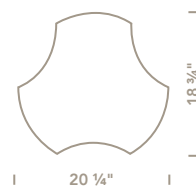

Shapes and Sizes

3D Panels

3D Shapes are only available in Quiet-Core™ Substrate

Diamond 3D

Small



Medium



Large

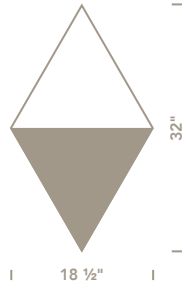

Square 3D

Small



Large

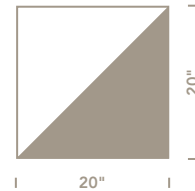

Hex 3D

Small



Medium

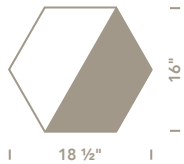

Large

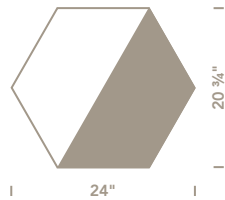

Waveline 3D

Small



Medium

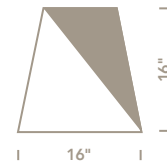

Large

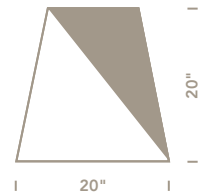

Xorel[®] Fabrics











Xorel Artform offers over 300 Xorel colors, patterns and textures to meet your design expectations

What is Xorel[®]?

Xorel is Carnegie's high performance, innovative and sustainable interior textile. Xorel was designed from a simple 3 – part premise:

- Create a textile whose high performance is inherent to the raw material
- Leverage its woven construction to enable a wide variety of aesthetic possibilities
- Ensure its affect on the environment is always minimal and could always be improved

Xorel[®] is...

 DURABLE From 200,000 to 1 million double rubs wyzenbeek	 COLORFAST A solution dyed product Impervious to many stains
 ANTIBACTERIAL Inherently antibacterial, fungal & staph	 3rd party certified Cradle-to-cradle MBDC Silver & Gold SCS Indoor Air quality Gold Vinçotte OK biobased facts Certified Silver & Gold USDA BioPreferred
 END OF LIFE Safety disposable Responsible return program	 APPROVED Green Spec listed Approval under Collaborative for High Performance Schools LBC & HPD complaint
 EASILY CLEANED Can be aggressively cleaned on the wall Water, solvent and diluted bleach cleanable X Protect backing technology	 PROTECTED 10-year warranty
 NO FINISHES Clean production No topical finishes or chemical finishes	
 LAB TESTED 60+ performance and safety tests	



FACTS Certified



Vinçotte Certified
Levels 3 & 4



Cradle to Cradle
Silver & Gold Certification



SCS Indoor Advantage
Gold Certification

Substrate Options and Acoustical Performance

Xorel Artform is available in two substrates: **Quiet-Core™** and **Mi-Core™**

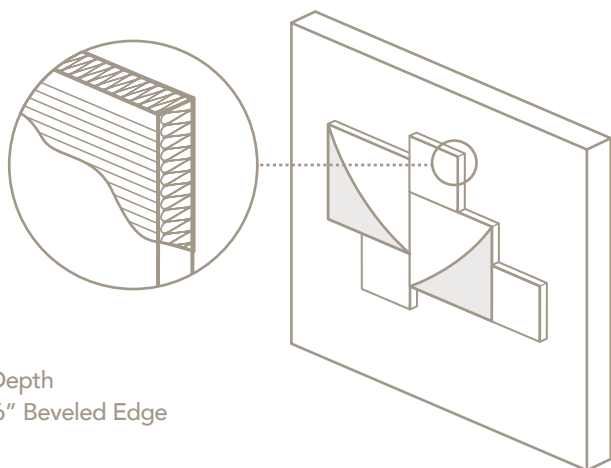

1" Depth
3/16" Beveled Edge

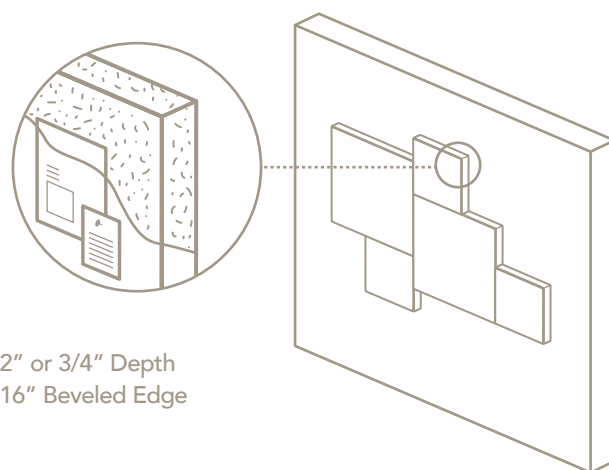

1/2" or 3/4" Depth
3/16" Beveled Edge

Quiet-Core™

This acoustical substrate is sound absorbing, formaldehyde-free and manufactured with 20% post-consumer recovered materials. It is available in a 1" thickness and used for all 3D shapes. It meets ASTM E84 Class A/Class 1.

Acoustical Performance

250Hz	.32
500Hz	.71
1000Hz	.98
2000Hz	1.10
4000Hz	.98
NRC	.70

Mi-Core™

This tackable substrate offers moderate acoustical properties. Mi-Core™ is constructed with inorganic minerals and fibers making it resistant to moisture and warping. Mi-Core is a dense material recommended for high traffic areas. It is available in 1/2" & 3/4" thickness. It meets ASTM E84 Class A/Class 1.

Acoustical Performance

250Hz	.18
500Hz	.31
1000Hz	.36
2000Hz	.41
4000Hz	.46
NRC	.30

How to Order?

Xorel Artform is priced and sold in box sets of the same shape, size, substrate, fabric, and color.

Complete box sets include 6 prefabricated panels of the standard shapes; 4 panels per box for the 3D shapes. Each box arrives to the job site securely packed and includes all installation and adhesive materials. Minimum order is 1 box.

Standard Shape Box Set

6 panels

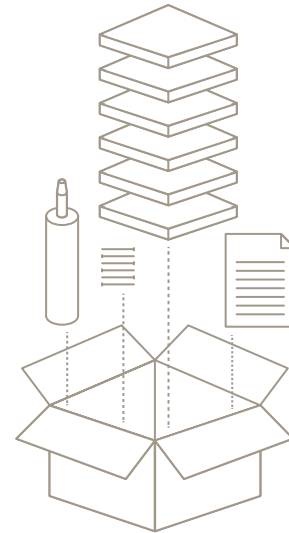

Dimensional Orientation

Box sets of **Hex**, **Waveline**, and **Square** 3D panels include "handed" shapes which feature the dimensional element oriented towards either right or left. This attention to detail ensures that the specified Xorel fabric weave is wrapped along the panel in the same direction so that fit and finish are not compromised when changing panel orientation. Two of each handed shape are included in each box set.

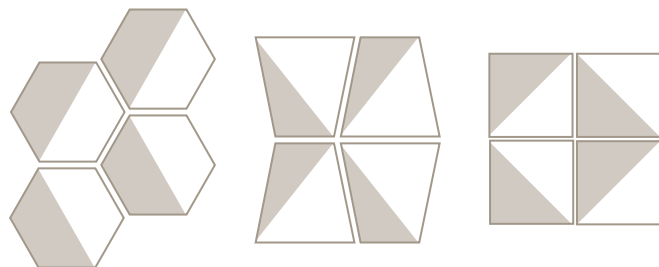

3D Shape Box Set

4 panels

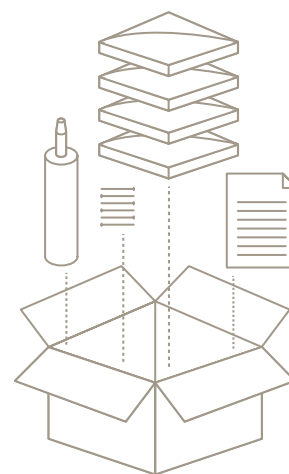

Install with Ease

Lightweight panels, easy install

Fast and easy to install with little disruption or major clean up, Xorel Artform is the optimal solution to address post-occupancy acoustical issues. Panels are lightweight and install simply with a quick-grab adhesive or Velcro® fasteners, eliminating the high labor costs associated with rail and hardware systems.



Beyond Walls: Ceiling Suspension

Versatility in application is easily achieved because Xorel Artform is uninhibited by clips or track systems. This creates opportunity for free form layouts that can extend on to ceilings.

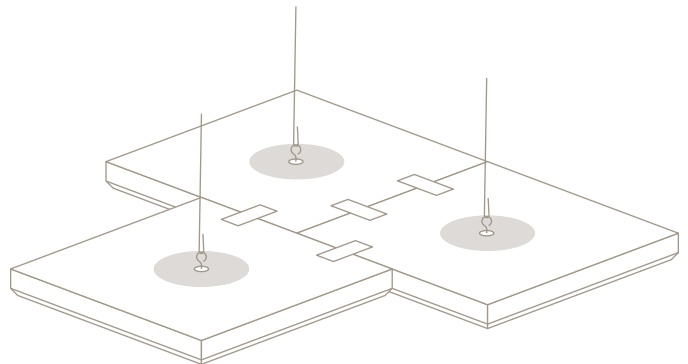

Warranty

5 Year Warranty

For repairs/replacement of any or all Xorel Artform panels that may prove defective in workmanship or materials (adhesive/velcro*) or performance for a period of 5 years from purchase. Ordinary wear and tear, unacceptable temperature/humidity variation, botched/poor installation and unusual abuse or neglect is excluded.

*Correct installation method must be selected (considering panel substrate and wall substrate). The installation instructions were followed and the panels are being used with industry standard limitations.

Questions? email service@carnegiefabrics.com